

PRODUCT DESCRIPTION

RAMI Part Number	AV-1FG
NSN	Not Assigned
Market	Aviation - Land

The AV-1FG is a base station antenna for communications mounted on top of a quick erect fiberglass telescoping mast which can be extended anywhere from approximately 5' 6" to 27' tall in 5' increments. The mast is supplied with guy rings, guy ropes and anchor stakes for security when erected. This kit can be used with Becker Avionics GK615 and GK616 VHF radios.

AV-1 Antenna SPECIFICATIONS

Application	VHF Communications
Frequency	118-137 MHz
Impedance	50 Ohms Nominal
VSWR	2.0:1
Polarization	Maximum Vertical
Pattern	Omni-Directional
Connector	SO-239
Max Weight	2.75 lbs
Max Height	37"
RF Power Capacity	500 Watts

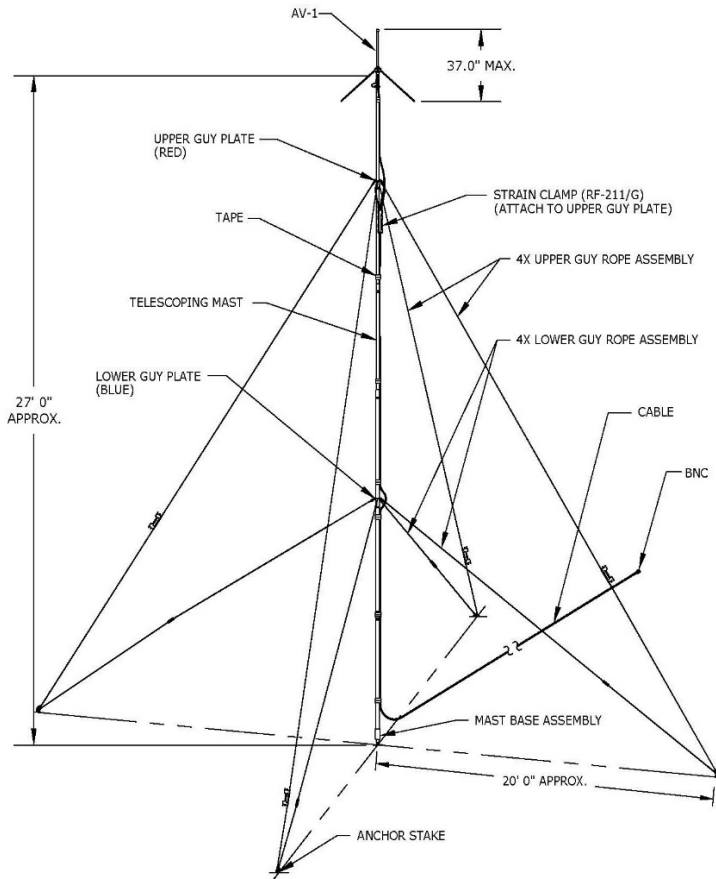

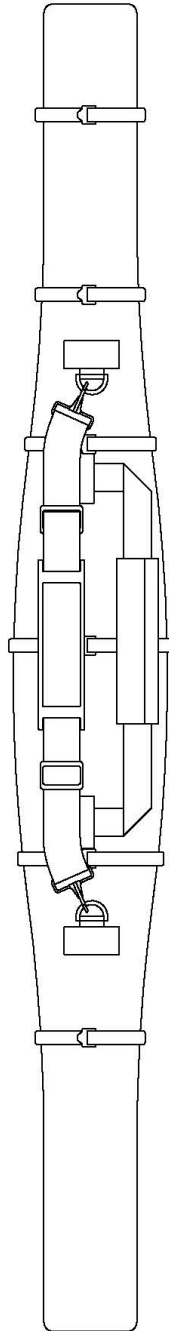

TRANSIT BAG
P/N: R254E-BG
(ONE) REQ'D.



TELESCOPING MAST
W/GUY PLATES
P/N: M50-201A
(ONE) REQ'D.

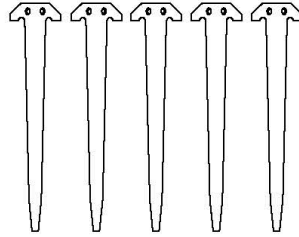

ANCHOR STAKE
P/N: RAMI50-50
(4) REQ'D. + (ONE) SPARE

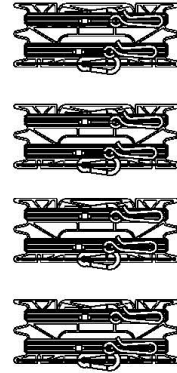

GUY ROPE ASSEMBLY
P/N: RAMI50-40
(4) REQ'D.



PLATE
P/N: A3002872
(ONE) REQ'D.

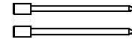

STAKE
P/N: 729924
(2) REQ'D.

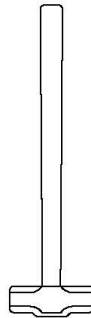

HAMMER
P/N: H86-X-1
(ONE) REQ'D.

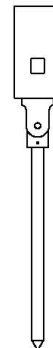

MAST BASE ADAPTER
P/N: RAMI50-30
(ONE) REQ'D.



ANTENNA MAST ADAPTER
P/N: AV-1-101A
(ONE) REQ'D.

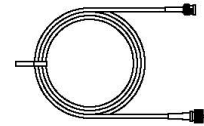

CABLE ASSEMBLY
UHF/BNC 50' RG-58A/U
P/N: AV-1-201A
(ONE) REQ'D.

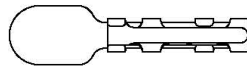

PF-211/G STRAIN CLAMP
P/N: 14204
(ONE) REQ'D.

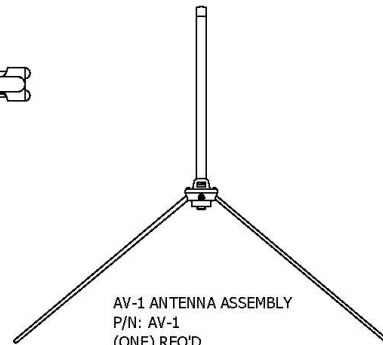

AV-1 ANTENNA ASSEMBLY
P/N: AV-1
(ONE) REQ'D.